

MODEL RANGE

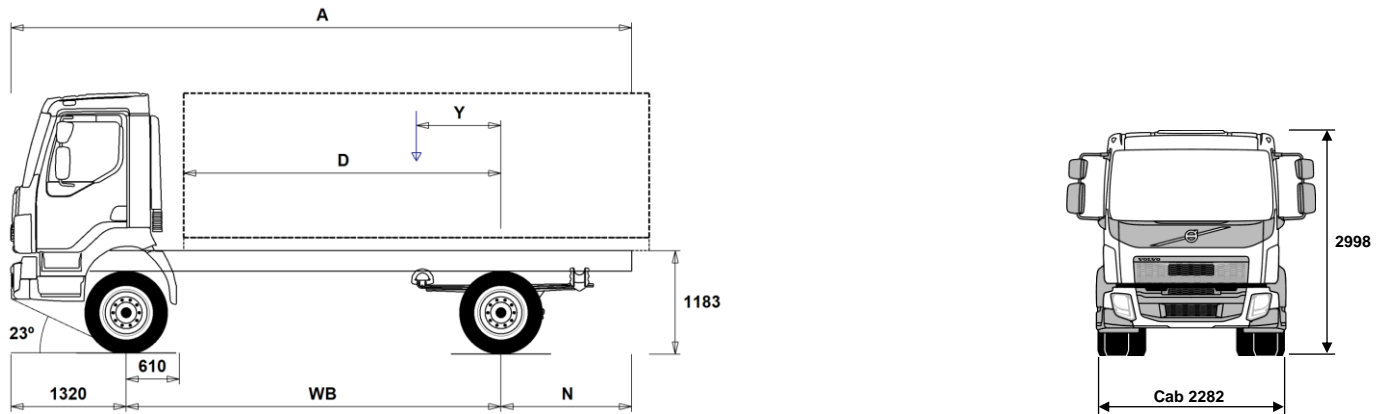

Volvo Trucks. Driving Progress

FL814 4x4 Rigid 14 tonne - Steel Suspension FL 44 R 814L



Chassis Dimensions [mm]

WB Wheelbase	3350	3500	3800	4100
A Overall Chassis Length	6645	6975	7425	7955
D Center of rear axle to front of body	2690	2840	3140	3440
N Rear Overhang (Min.)	1515	1685	1885	2085
N Rear Overhang (Max.)	1975	2155	2305	2535
Y Center of Gravity for Payload (Min.)	459	483	524	568
Y Center of Gravity for Payload (Max.)	772	810	881	954

Chassis Weights [kg]

Front Axle	3625	3620	3625	3625
Rear Axle	1815	1835	1860	1885
Kerb Weight	5440	5455	5485	5510
Payload (including body, driver, fuel, etc.)	8560	8545	8515	8490

Turning Diameter [mm]

Turning Circle Diameter Kerb to Kerb	14200	14700	15800	16900
Turning Circle Diameter Wall to Wall	15200	15700	16800	17900

Plated Weights [kg]

	Plated	Design
Gross Vehicle Weight	14000	14000
Gross Combination Weight	16500	16500
Front Axle	5600	5600
Rear Axle	9200	9200

Important Notes

Chassis Dimensions

Cab Height: +39 mm for CAB-CRW.
 Front Axle to Back of Cab: +1230 mm for CAB-CRW, +237 mm for CAB-SSLP.
 D-measure includes a front clearance of 50 mm and for rigid trucks also a subframe of 120 mm.
 Height can vary ± 20 mm for leaf and ± 10 mm for air suspension.
 All dimensions are for unladen chassis and any tag axles down.

Weight and dimensions are based upon the following tyres:
 Front Axle Tyres: 275/70R22.5
 Drive Axle Tyres: 275/70R22.5

Chassis weight includes oil, water, AdBlue, 0 litres fuel and without driver. Kerb weight can vary $\pm 3\%$.

Turning diameters are theoretically calculated.

Legal weights can differ from country to country.

For more detailed weight information, including optional equipment weights, ask your Volvo sales contact to enter your specification into the Volvo Weight Information system (WIS).

Do NOT use this drawing for bodybuilding. Refer to Volvo Bodybuilder Instructions and chassis assembly drawing FL44R814L.

MODEL RANGE

FL814 4x4 Rigid 14 tonne - Steel Suspension FL 44 R 814L

TRUCK USE

- **UNIFORM** Basic platform vehicle

CORE COMPONENTS

- **RAD-L80** 80mm parabolic rear springs
- **EU6SCR** Emission level - Euro 6
- **D8K250** D8K250 six cylinder 7.7 litre engine developing 250hp at 2100rpm.
Peak torque 950Nm at 900-1700rpm.
- **D8K280** D8K280 six cylinder 7.7 litre engine developing 280hp at 2100rpm.
Peak torque 1050Nm at 950-1700rpm.
- **EBR-CEB** Exhaust brake producing 170kW at 2800rpm controlled by steering column switch
- **EBR-EPG** Exhaust brake producing 120kW at 2800rpm controlled by steering column switch
- **ZTO1006** 6-speed overdrive gearbox

Packages

- **DRIVEFL** NEW drive package FL
- **VISIFL** NEW visibility package FL
- **AUDIODAB** Digital DAB AM/FM Radio with Bluetooth - without CD player
- **AUDIOPD** Preparation for DAB radio including amplifier and aerial

CHASSIS

- **FST-PAR3** Stiff parabolic front springs with shock absorbers and anti roll bar
- **FAL5.6** Front axle design capacity 5.6 tonnes
- **RAL9.2** Rear axle design capacity 9.2 tonnes
- **RSTAB1** Rear anti-roll bar
- **EBS-MED** EBS+ package including traction control & hill hold
- **RST-PAR3** Stiffer parabolic rear springs
- **FST8080** Frame thickness 8mm
- **2BATT170** 2 x 170 Ah capacity batteries on left hand side
- **R130P** 130 litre right hand plastic fuel tank
Min volume 130l
Max volume 215l
- **UL-FUEL** Without left fuel tank
- **ADTP-R** AdBlue tank on right hand side
- **WHC-FIX1** One wheel chock
- **WHC-FIX2** Two wheel chocks
- **TOWMBRH** Towing member, high position, mounted in centre of frame
- **C-RO40AG** Rockinger 400 G145
- **TOWF-NO1** One towing device in front.
- **TOWF-NO2** Two towing devices in front.
- **TOWR-ONE** Pintle type towing hitch attached to rear crossmember for 3.5tonne trailer
- **TREL15** Single 15 pole electrical trailer connector - ADR certified
- **TBC-EC**
- **RFEND-T** Mudwings on drive axle for transportation only

WHEELS & TYRES

- **SPWT-F** Spare wheel & tyre with front tyre pattern
- **SWCP-T** Spare wheel supplied temporarily strapped to chassis
- **SWCP-TP** Spare wheel carrier transport mounted on frame (spare wheel carrier not included)
- **JACK-10T** 10 tonne bottle jack
- **GAUGE-TP** Tyre pressure gauge

- Standard Equipment
- Optional Equipment

For more detailed information about cab and powertrain equipment, please refer to separate specification sheets.

For all possible options and combinations of options please consult your Volvo sales contact who can create a specification to match your requirements using the Volvo Sales Support system (VSS).

The factory reserves the right to modify design and change equipment without previous notification.
The specification can vary from country to country.

DRIVELINE EQUIPMENT

- **CS39A-O** Single plate 395mm (16") clutch
- **1COMP500** Single cylinder air compressor 360 cc / 500 l/min
- **2COM1080** Two cylinder, air compressor, 1080 litres per minute
- **AIRIN-HI** High air intake behind cab on left hand side
- **AIRIN-RL** Chassis mounted mounted behind cab on right hand side
- **ACL1ST** Air cleaner with one filter element
- **ACL1ST-S** Air filter with secondary filter element
- **24AL110B** 110 amp alternator
- **CCV-C** Closed crankcase ventilation
- **CCV-OX** Open crankcase ventilation with oil separator and a maintenance free gas centrifuge
- **EST-AID** Air inlet manifold starting heater element
- **PTER-100** Rear engine mounted power-take-off with DIN 7476 flange
- **PTER-DIN** Rear engine mounted PTO with DIN5462 (female) splined shaft for a close coupled pump
- **PTER1400** Rear engine mounted power-take-off with SAE 1410 flange
- **PTR-FH5** Rear PTO Gearbox S88 flange DIN connection
- **PTR-PH4** Rear PTO Gearbox S88 pump DIN connection
- **PTR-PK** Electrical and solenoid prep kit for gearbox PTO
- **PTR-ZF4** Rear PTO Gearbox 320Nm flange connection
- **PTR-ZF6** Rear PTO Gearbox 320Nm flange connection
- **ETC** Electronic throttle control - dash mounted switch for PTO speed control

CAB INTERIOR

- **STWPOS-L** LEFT HAND DRIVE
- **STWPOS-R** RIGHT HAND DRIVE

CAB EXTERIOR

- **SUNV-B** Exterior sun visor - smoked grey
- **SUNV-PK** Sunvisor installation preparation kit
- **BEACON-P** Beacon preparation
- **BEACONA2** Two amber beacons directly mounted to cab roof

SUPERSTRUCTURE PREPARATIONS

- **FBA-BTF** Lower front body attachments for torsionally flexible - platform body
- **FBA-BTSF** Lower front body attachments for torsionally semi-flexible body - box or curtainsider
- **RBA-T2** Rear body attachments, divided
- **TAILPREP** Taillift preparation kit - cab switch and warning in driver display

DELIVERY SERVICES

- **TGW-4G** GSM/GPRS/4G modem, WLAN for telematics gateway
- **WVTA** Whole Vehicle Type Approved - MANDATORY for standard truck

MODEL RANGE

FL814 4x4 Rigid 14 tonne - Steel Suspension FL 44 R 814L

VOLVO

Volvo Truck Corporation
volvotrucks.com